

# Audo

COPENHAGEN



KUBUS COLLECTION  
Designed by *by Lassen*



KUBUS MICRO  
Designed by *Audo*

A new small wonder has seen the light of day. Kubus Micro is a stylish, smaller version of the iconic Kubus candleholder and is designed by Audo in 2021. It is based on the exact same mathematical geometry as The very first Kubus Candleholder Mogens Lassen designed in 1962. Just very much smaller. Precisely half the size of Kubus 1. The black Kubus-shape frames the light beautifully and adds a minimalist expression to the table setting. Kubus Micro fits a single candle and is perfect for all kinds of festivities, where the table must be beautifully laid, and you want a very special atmosphere. The candleholder works alone in a beautiful still life or arrange several together for a greater effect. A beautiful table for the last celebrations of the year Kubus Micro creates just the right atmosphere at this year's Christmas and New Year table for a sharp and minimalist expression. The black cubistic shapes add a graphic and timeless element, and the iconic design can therefore act as the mainstay of the table setting year after year. The expression on the Christmas table can easily be varied with flowers, s or new tableware, while Kubus Micro acts as a traditional eye-catcher year after year. If you keep the table setting in black, silver and white, the same elements can also be used for a festive New Year's Eve. Kubus Micro comes in a package with 2 small candleholders, so they can decorate nicely together in the windowsill, on the dinner table, dresser or even as Advent candles.



BLACK  
BL12001



GOLD-PLATED  
BL12501

PRODUCT TYPE  
Candle Holder

COLLI  
6

ENVIRONMENT  
Indoor

DIMENSIONS  
H: 3,5 cm / 1,4"  
W: 3,5 cm / 1,4"  
D: 3,5 cm / 1,4"

TECHNICAL SPECIFICATIONS

PRODUCTION PROCESS  
The candleholder is casted with zinc and vibration deburred. Afterwards the candleholder is powder coated.

COLOURS  
Black (RAL 9005)  
Gold-Plated

MATERIALS  
Zinc alloy

WEIGHT  
0,255 kg / 0,56 lbs

PACKAGING TYPE  
Gift box

PACKAGING MEASUREMENTS  
(H × W × D)  
7 cm × 7 cm × 12,2 cm / 2,8" × 2,8" × 4,8"

MATERIALS & MAINTENANCE  
Please visit [audocph.com](http://audocph.com) for materials, care and maintenance instructions.

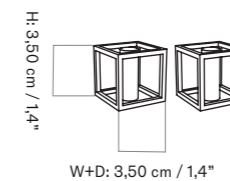



# KUBUS 1

Designed by *Mogens Lassen*

With a sharp sense of contemporary Functionalist style, Mogens Lassen designed the iconic Kubus candleholder in 1962, a piece once reserved solely for family and close architect colleagues. The Kubus is still crafted in Denmark, and among architects and design connoisseurs it has achieved the status of a modern international design icon. The story about Kubus 1: Architect Mogens Lassen was commissioned to design the interior for a restaurant in North Zealand, Denmark, and it was within the context of this assignment that the Kubus 1 was born. The square-shaped Kubus 1 gathered people around the table just as Mogens intended, and its characteristic shape and simple light created an atmosphere of coziness throughout the entire restaurant. The Kubus 1 still decorates tables in the very same restaurant, because good design lives on for generations.



BLACK  
BL10001



WHITE  
BL10101



GOLD-PLATED  
BL10501

PRODUCT TYPE  
Candle Holder

COLLI  
4

ENVIRONMENT  
Indoor

DIMENSIONS  
H: 7 cm / 2,8"  
W: 7 cm / 2,8"  
D: 7 cm / 2,8"

## TECHNICAL SPECIFICATIONS

PRODUCTION PROCESS  
The candleholder is casted with zinc and vibration deburred. Afterwards the candleholder is powder coated.

COLOURS  
Black (RAL 9005)  
White  
Gold-Plated

MATERIALS  
Zinc alloy

WEIGHT  
0,356 kg / 0,78 lb

PACKAGING TYPE  
Gift box

PACKAGING MEASUREMENTS  
(H × W × D)  
8 cm × 8 cm × 8 cm / 3,2" × 3,2" × 3,2"

MATERIALS & MAINTENANCE  
Please visit [audocph.com](http://audocph.com) for materials, care and maintenance instructions.

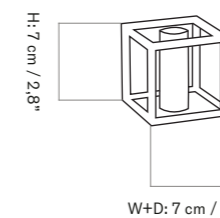



KUBUS T  
Designed by *Søren Lassen*

The tealight, Kubus T, was added to the Kubus collection in 2018, designed by Sarah Abbondio. Simplistically and graphic stringency is the keywords describing the candleholder. Choose the classic powder-coated versions, the raw burnished copper, which over time will darken beautifully, gold-plated or the beautiful, shiny nickel version, which is warm and unique in its glow - or combine more for a beautiful, sculptural Still Life on the windowsill or on dinner table.



BLACK  
BL10031



WHITE  
BL10131



GOLD-PLATED  
BL10531

PRODUCT TYPE  
Candle Holder

COLLI  
4

ENVIRONMENT  
Indoor

DIMENSIONS  
H: 7 cm / 2,8"  
W: 7 cm / 2,8"  
D: 7 cm / 2,8"

TECHNICAL SPECIFICATIONS

PRODUCTION PROCESS  
The candleholder is casted with zinc and vibration deburred. Afterwards the candleholder is powder coated.

COLOURS  
Black (RAL 9005)  
White  
Gold-Plated

MATERIALS  
Zinc alloy

WEIGHT  
0,355 kg / 0,78 lb

PACKAGING TYPE  
Gift box

PACKAGING MEASUREMENTS  
(H × W × D)  
7,5 cm × 7,5 cm × 7,5 cm / 3" × 3" × 3"

MATERIALS & MAINTENANCE  
Please visit [audocph.com](http://audocph.com) for materials, care and maintenance instructions.

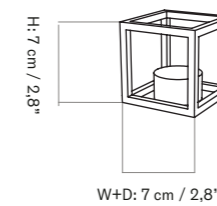



KUBUS 4  
Designed by *Mogens Lassen*

With a sharp sense of contemporary Functionalist style, Mogens Lassen designed the iconic Kubus candleholder in 1962, a piece once reserved solely for family and close architect colleagues. The Kubus is still crafted in Denmark, and among architects and design connoisseurs it has achieved the status of a modern international design icon.



BLACK  
BL10004



WHITE  
BL10104



ZINC  
4817169



OLIVE  
4817429



IVORY  
4817649



NICKEL-PLATED  
BL10204



GOLD-PLATED  
BL10504



BURNISHED COPPER  
BL10704

PRODUCT TYPE  
Candle holder

COLLI  
Colours black, white, zinc, olive and ivory:  
6 pcs.  
Colours nickel-plated, gold-plated and  
burnished copper: 2 pcs.

ENVIRONMENT  
Indoor

DIMENSIONS  
H: 20 cm / 7,9"  
W: 14 cm / 5,5"  
D: 14 cm / 5,5"

TECHNICAL SPECIFICATIONS

PRODUCTION PROCESS  
The candleholder is casted with zinc  
and afterwards shot blasted before the  
candleholder is powder coated.

COLOURS  
Black (RAL 9011)  
White (RAL 9010)  
Zinc  
Olive (RAL 7008)  
Ivory (RAL 1015)  
Nickel-Plated  
Gold-Plated  
Burnished Copper

MATERIALS  
Zinc alloy

WEIGHT  
Nickel-Plated: 1,224 kg / 2,7 lb  
Gold-Plated: 1,224 kg / 2,7 lb  
Burnished Copper: 1,211 kg / 2,67 lb  
Painted versions: 1,246 kg / 2,75 lb

PACKAGING TYPE  
Gift box

PACKAGING MEASUREMENTS  
(H x W x D)  
21 cm x 16,5 cm x 16,5 cm /  
8,3" x 6,5" x 6,5"

MATERIALS & MAINTENANCE  
Please visit [audocph.com](http://audocph.com) for materials, care  
and maintenance instructions.

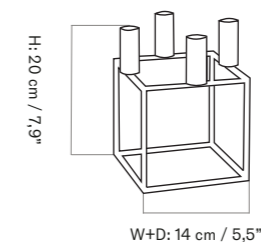



KUBUS 8  
Designed by *Mogens Lassen*

With a sharp sense of contemporary Functionalism style, Mogens Lassen designed the iconic Kubus candleholder in 1962, a piece once reserved solely for family and close architect colleagues. The Kubus is still crafted in Denmark, and among architects and design connoisseurs it has achieved the status of a modern international design icon.



BLACK  
BL10008



WHITE  
BL10108



GOLD-PLATED  
BL10508



BURNISHED COPPER  
BL10708

PRODUCT TYPE  
Candle Holder

COLLI  
2

ENVIRONMENT  
Indoor

DIMENSIONS  
H: 29 cm / 11,4"  
W: 23 cm / 9,1"  
D: 23 cm / 9,1"

TECHNICAL SPECIFICATIONS

PRODUCTION PROCESS  
The candleholder is casted with zinc and vibration deburred. Afterwards the candleholder is powder coated.

COLOURS  
Black (RAL 9005)  
White  
Gold-Plated  
Burnished Copper

MATERIALS  
Zinc alloy

WEIGHT  
Black: 1,322 kg / 2,91 lb  
White: 1,322 kg / 2,91 lb  
Gold-Plated: 1,297 kg / 2,86 lb  
Burnished Copper: 1,296 kg / 2,86 lb

PACKAGING TYPE  
Gift box

PACKAGING MEASUREMENTS  
(H × W × D)  
30 cm × 26 cm × 26 cm /  
11,8" × 10,2" × 10,2"

MATERIALS & MAINTENANCE  
Please visit [audocph.com](http://audocph.com) for materials, care and maintenance instructions.

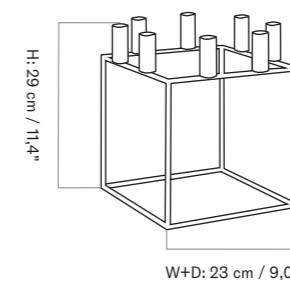



BASE FOR KUBUS  
Designed by *Jacob Manz*

Base was designed in 2009 as an accessory for Kubus and Line to protect surfaces from dripping candle wax. Base beautifully frames the candleholders and emphasizes the simple design of both Kubus and Line. Base has been designed with the greatest respect for the architect Mogens Lassen – both as an architect and as a designer.

*Base for Kubus 4*

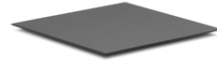

BLACK  
BL10014



WHITE  
BL10114

*Base for Kubus 8*

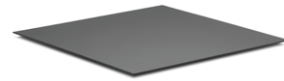

BLACK  
BL10018



WHITE  
BL10118

TECHNICAL SPECIFICATIONS

PRODUCT TYPE  
Candle Holder

COLLI  
4

ENVIRONMENT  
Indoor

DIMENSIONS

*Base for Kubus 4*  
W: 21 cm / 8,3"  
D: 21 cm / 8,3"

*Base for Kubus 8*  
W: 30 cm / 11,8"  
D: 30 cm / 11,8"

PRODUCTION PROCESS  
The base is made from a 2 mm steel plate, that is laser cut into the right dimension. Afterwards 6 x 6 mm steel bars are welded on the plate before the base is degreased and powder coated.

COLOURS  
Black (RAL 9005)  
White

MATERIALS  
Powder coated steel

WEIGHT  
Base for Kubus 4: 1,3 kg / 2,87 lb  
Base for Kubus 8, Black: 1,787 kg / 3,94 lb  
Base for Kubus 8, White: 1,676 kg / 3,69 lb

PACKAGING TYPE  
Gift box

PACKAGING MEASUREMENTS  
(H x W x D)

*Base for Kubus 4*  
3 cm x 22 cm x 23 cm / 1,18" x 8,66" x 9,06"

*Base for Kubus 8*  
3 cm x 31 cm x 32 cm / 1,18" x 12,2" x 12,6"

MATERIALS & MAINTENANCE  
Please visit [audocph.com](http://audocph.com) for materials, care and maintenance instructions.

BASE FOR KUBUS 4

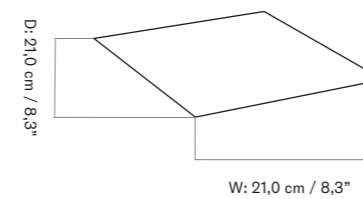

BASE FOR KUBUS 8

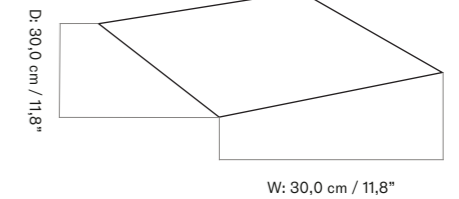



# KUBUS LINE

Designed by *Mogens Lassen*

With a sharp sense of contemporary Functionalist style, Mogens Lassen designed the iconic Kubus candleholder in 1962, a piece once reserved solely for family and close architect colleagues. In 1983 he reapproached his own geometric candleholders, and the result was Line, whose shape was conceived through a mathematical formula. The two candleholders form a single line, and the architectural look fits perfectly with contemporary minimalism. Kubus and Line is still crafted in Denmark, and among architects and design connoisseurs it has achieved the status of a modern international design icon.



BLACK  
BL10002



WHITE  
BL10102



GOLD-PLATED  
BL10502

PRODUCT TYPE  
Candle Holder

COLLI  
4

ENVIRONMENT  
Indoor

DIMENSIONS  
H: 16 cm / 6,2"  
W: 10 cm / 3,9"  
D: 10 cm / 3,9"

## TECHNICAL SPECIFICATIONS

PRODUCTION PROCESS  
The candleholder is casted with zinc and afterwards shot blasted before the candleholder is powder coated.

COLOURS  
Black (RAL 9005)  
White  
Gold-Plated

MATERIALS  
Steel

WEIGHT  
0,901 kg / 1,99 lb  
Gold-Plated: 0,445 kg / 0,98 lb

PACKAGING TYPE  
Gift box

PACKAGING MEASUREMENTS  
(H x W x D)  
17 cm x 11 cm x 12,5 cm / 6,7" x 4,3" x 4,9"

MATERIALS & MAINTENANCE  
Please visit [audocph.com](http://audocph.com) for materials, care and maintenance instructions.

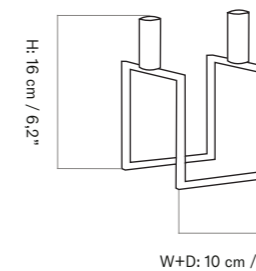





BASE FOR KUBUS LINE  
Designed by *Jacob Manz*

Base was designed in 2009 as an accessory for Kubus and Line to protect surfaces from dripping candle wax. Base beautifully frames the candleholders and emphasizes the simple design of both Kubus and Line. Base has been designed with the greatest respect for the architect Mogens Lassen – both as an architect and as a designer.

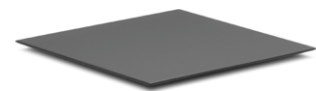

BLACK  
BL10012



WHITE  
BL10112

PRODUCT TYPE  
Candle Holder

COLLI  
4

ENVIRONMENT  
Indoor

DIMENSIONS  
W: 16,8 cm / 6,6"  
D: 16,8 cm / 6,6"

TECHNICAL SPECIFICATIONS

PRODUCTION PROCESS  
The base is made from a 2 mm steel plate, that is laser cut into the right dimension. Afterwards 6 x 6 mm steel bars are welded on the plate before the base is degreased and powder coated.

COLOUR  
Black (RAL 9005)  
White

MATERIALS  
Powder coated steel

WEIGHT  
Black: 0,901 kg / 1,99 lbs  
White: 0,651 kg / 1,44 lbs

PACKAGING TYPE  
Gift box

PACKAGING MEASUREMENTS  
(H x W x D)  
3 cm x 17,5 cm x 19 cm / 1,2" x 6,9" x 7,5"

MATERIALS & MAINTENANCE  
Please visit [audocph.com](http://audocph.com) for materials, care and maintenance instructions.

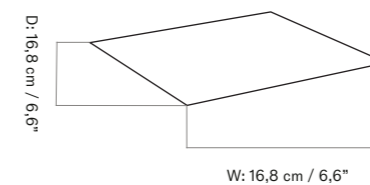

KUBUS SNUFFER  
 Designed by *Søren Lassen*

With reference to the iconic Kubus candleholders, the Kubus Snuffer in black is an essential addition to the collection. Avoid drips and wax stains and keep your candleholder pristine by using the snuffer instead of blowing out the candles. With the same cubic metal frame and side length as the Kubus 8 candleholder, the snuffer is designed to be showcased as a natural extension to your candleholder.



BLACK  
 BL11001

TECHNICAL SPECIFICATIONS

PRODUCT TYPE  
 Decor

COLLI  
 6

ENVIRONMENT  
 Indoor

DIMENSIONS  
 W: 21 cm / 8,3"  
 D: 3,7 cm / 1,5"

PRODUCTION PROCESS  
 Kubus Snuffer is made in steel and powder coated.

COLOUR  
 Black (RAL 9005)

MATERIALS  
 Powder coated steel

WEIGHT  
 0,079 kg / 0,17 lbs

PACKAGING TYPE  
 Gift box

PACKAGING MEASUREMENTS  
 (H x W x D)  
 3 cm x 4 cm x 22 cm / 1,2" x 1,6" x 8,7"

MATERIALS & MAINTENANCE  
 Please visit [audocph.com](http://audocph.com) for materials, care and maintenance instructions.

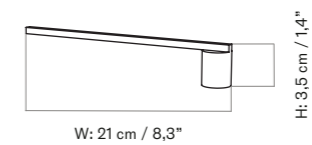



# KUBUS WALL BRACKET

Designed by *Søren Lassen*

Kubus Wall Bracket is for the Kubus collection containers, enabling hangers, planters and vases to be mounted directly on the wall for a light, airy botanical feel that embodies the best of both inside and out. The package contains 2 pcs. of wall brackets.

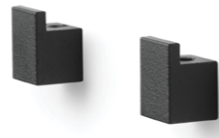

BLACK  
BL11003

## TECHNICAL SPECIFICATIONS

PRODUCT TYPE  
Wall Bracket

COLLI  
12

ENVIRONMENT  
Indoor

DIMENSIONS  
H: 1,5 cm / 0,59"  
W: 1 cm / 0,39"  
D: 1 cm / 0,39"

COLOURS  
Black (RAL 9005)

MATERIALS  
Steel

WEIGHT  
0,022 kg / 0,05 lb

PACKAGING TYPE  
Gift box

PACKAGING MEASUREMENTS  
(H x W x D)  
7,8 cm x 3 cm x 12,2 cm /  
3,07" x 1,18" x 4,8"

MATERIALS & MAINTENANCE  
Please visit [audocph.com](http://audocph.com) for materials, care and maintenance instructions.

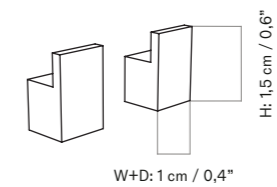



# CANDLES, 16 PCS Designed Audo

16 black, white and grey candles for Kubus and Line candleholders.



BLACK  
BL11015



WHITE  
BL11116



GREY  
BL11315

## TECHNICAL SPECIFICATIONS

PRODUCT TYPE  
Candle

COLLI  
6

ENVIRONMENT  
Indoor

DIMENSIONS  
H: 20 cm / 7,9"  
W: 2 cm / 0,8"  
D: 2 cm / 0,8"

PRODUCTION PROCESS  
The candles are made from candle wax.

COLOUR  
Black (RAL 9005)  
White  
Grey

MATERIALS  
Wax

WEIGHT  
1,186 kg / 2,61 lbs

BURNING HOURS  
8 hours

PACKAGING TYPE  
Gift box

PACKAGING MEASUREMENTS  
(H x W x D)  
10 cm x 10 cm x 21 cm /  
3,94" x 3,94" x 8,27"

MATERIALS & MAINTENANCE  
Please visit [audocph.com](http://audocph.com) for materials, care and maintenance instructions.



CANDLES FOR KUBUS MICRO, 9 PCS  
Designed Audø

These little candles are a perfect match for the Kubus Micro candleholder. The package consists of 9 white candles.



WHITE  
BL11200

TECHNICAL SPECIFICATIONS

PRODUCT TYPE  
Wall Bracket

PRODUCTION PROCESS  
The candles are made from candle wax.

PACKAGING TYPE  
Gift box

COLLI  
12

COLOURS  
White

PACKAGING MEASUREMENTS  
(H x W x D)  
7,8 cm x 3 cm x 12,2 cm /  
3,07" x 1,18" x 4,8"

ENVIRONMENT  
Indoor

MATERIALS  
Wax

MATERIALS & MAINTENANCE  
Please visit [audocph.com](http://audocph.com) for materials, care and maintenance instructions.

DIMENSIONS  
H: 21,5 cm / 8,5"  
Ø: 1,3 cm / 0,6"

WEIGHT  
0,022 kg / 0,05 lb





# KUBUS BOWL, SMALL

Designed by *Søren Lassen*

The Kubus Bowl is designed by Søren Lassen, and features elements evocative of the Bauhaus school, one of Mogens Lassen's primary inspirations. The German design school believed that good design should be accessible to the people, and this concept appealed to architect Mogens Lassen. The Kubus Bowl is produced in Denmark with a focus on high quality and solid craftsmanship, and the bowl is a natural extension of the iconic Kubus candleholder, designed by Mogens Lassen in 1962. The Kubus Bowl is suitable for home decoration year-round and can contain everything from blossoms to herbs, fruits, vegetables or your favorite candy.



BLACK  
BL20001



WHITE  
BL20101



GOLD-PLATED  
BL20701

PRODUCT TYPE  
Bowl

COLLI  
2

ENVIRONMENT  
Indoor

DIMENSIONS  
H: 14 cm / 5,5"  
W: 14 cm / 5,5"  
D: 14 cm / 5,5"

## TECHNICAL SPECIFICATIONS

PRODUCTION PROCESS  
The frame is casted with zinc and shot blasted before it is powder coated. The bowl is casted with zinc and afterwards powder coated.

COLOURS  
Black  
White  
Gold-Plated

MATERIALS  
Powder coated zinc

WEIGHT  
0,994 kg / 2,19 lb  
Gold-Plated: 0,984 kg / 2,17 lb

CERTIFICATION  
Food safe when using inlay

PACKAGING TYPE  
Gift box

PACKAGING MEASUREMENTS  
(H x W x D)  
H: 21 cm, W: 16 cm, D: 17 cm /  
8,3" x 6,3" x 6,7"

MATERIALS & MAINTENANCE  
Please visit [audocph.com](http://audocph.com) for materials, care and maintenance instructions.

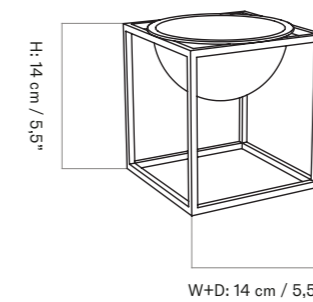



# KUBUS BOWL, LARGE

Designed by *Søren Lassen*

The Kubus Bowl is designed by Søren Lassen, and features elements evocative of the Bauhaus school, one of Mogens Lassen's primary inspirations. The German design school believed that good design should be accessible to the people, and this concept appealed to architect Mogens Lassen. The Kubus Bowl is produced in Denmark with a focus on high quality and solid craftsmanship, and the bowl is a natural extension of the iconic Kubus candleholder, designed by Mogens Lassen in 1962. The Kubus Bowl is suitable for home decoration year-round and can contain everything from blossoms to herbs, fruits, vegetables or your favorite candy.



BLACK  
BL20002



WHITE  
BL20102



GOLD-PLATED  
BL20702

PRODUCT TYPE  
Bowl

COLLI  
2

ENVIRONMENT  
Indoor

DIMENSIONS  
H: 23 cm / 9,0"  
W: 23 cm / 9,0"  
D: 23 cm / 9,0"

## TECHNICAL SPECIFICATIONS

PRODUCTION PROCESS  
The frame is casted with zinc and shot blasted before it is powder coated. The bowl is casted with zinc and afterwards powder coated.

COLOURS  
Black  
White  
Gold-Plated

MATERIALS  
Powder coated zinc

WEIGHT  
1,924 kg / 4,24 lb  
Gold-Plated: 1,809 kg / 3,99 lb

CERTIFICATION  
Food safe when using inlay

PACKAGING TYPE  
Gift box

PACKAGING MEASUREMENTS  
(H x W x D)  
H: 30 cm, W: 26 cm, D: 26 cm /  
11,8" x 10,2" x 10,2"

MATERIALS & MAINTENANCE  
Please visit [audocph.com](http://audocph.com) for materials, care and maintenance instructions.

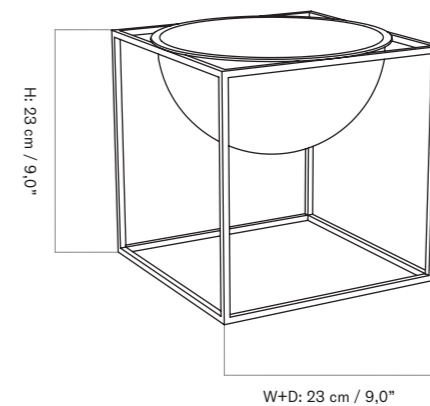



KUBUS BOWL CENTERPIECE, SMALL  
Designed by *Søren Lassen*

The dictionary definition is “an object occupying a central, especially an adornment in the center of a table” and the Kubus Centerpieces are nothing short of that; an embellishment to any dining table. The centerpieces, designed by Søren Lassen, draws on simple geometric shapes like the square and the hemisphere characteristic for the Kubus collection. Lower than Kubus Bowl, the pieces are perfect for lively flower arrangements, plants and any other creative decoration that would flatter a dinner setting. Every bowl comes with an inlay making it suitable for food and greenery.



BLACK  
BL23001



WHITE  
BL23101



GOLD-PLATED  
BL23701

PRODUCT TYPE  
Bowl

COLLI  
4

ENVIRONMENT  
Indoor

DIMENSIONS  
H: 7 cm / 2,8"  
W: 14 cm / 5,5"  
D: 14 cm / 5,5"

TECHNICAL SPECIFICATIONS

PRODUCTION PROCESS  
The frame is casted with zinc and shot blasted before it is powder coated. The bowl is casted with zinc and afterwards powder coated.

COLOURS  
Black  
White  
Gold-Plated

MATERIALS  
Powder coated zinc

WEIGHT  
1,171 kg / 2,58 lb

CERTIFICATION  
Food safe when using inlay

PACKAGING TYPE  
Gift box

PACKAGING MEASUREMENTS  
(H × W × D)  
10,5 cm × 16 cm × 16 cm / 4,1" × 6,3" × 6,3"

MATERIALS & MAINTENANCE  
Please visit [audocph.com](http://audocph.com) for materials, care and maintenance instructions.

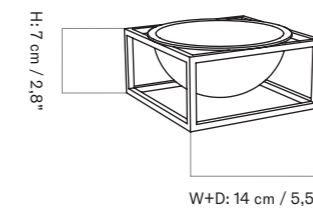





KUBUS BOWL CENTERPIECE, LARGE  
Designed by *Søren Lassen*

The dictionary definition is “an object occupying a central, especially an adornment in the center of a table” and the Kubus Centerpieces are nothing short of that; an embellishment to any dining table. The centerpieces, designed by Søren Lassen, draws on simple geometric shapes like the square and the hemisphere characteristic for the Kubus collection. Lower than Kubus Bowl, the pieces are perfect for lively flower arrangements, plants and any other creative decoration that would flatter a dinner setting. Every bowl comes with an inlay making it suitable for food and greenery.



BLACK  
BL23002



WHITE  
BL23102



GOLD-PLATED  
BL23702

PRODUCT TYPE  
Bowl

COLLI  
4

ENVIRONMENT  
Indoor

DIMENSIONS  
H: 11,5 cm / 4,5"  
W: 23 cm / 9,0"  
D: 23 cm / 9,0"

TECHNICAL SPECIFICATIONS

PRODUCTION PROCESS  
The frame is casted with zinc and shot blasted before it is powder coated. The bowl is casted with zinc and afterwards powder coated.

COLOURS  
Black  
White  
Gold-Plated

MATERIALS  
Powder coated zinc

WEIGHT  
2,574 kg / 5,67 lb

CERTIFICATION  
Food safe when using inlay

PACKAGING TYPE  
Gift box

PACKAGING MEASUREMENTS  
(H × W × D)  
15 cm × 26 cm × 26 cm / 5,9" × 10,2" × 10,2"

MATERIALS & MAINTENANCE  
Please visit [audocph.com](http://audocph.com) for materials, care and maintenance instructions.

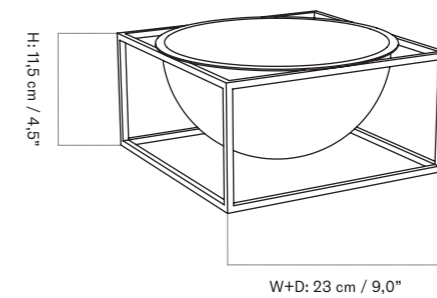



INLAY FOR KUBUS BOWL  
Designed by *Søren Lassen*

The Kubus Bowl is inspired by Mogens Lassen and incorporates elements from the Bauhaus period, which greatly influenced him in his work. The Kubus Bowl Inlay can be placed in the Kubus Bowl to protect the surface if wanting to use it for storing food or planting.

*Small*



BLACK  
BL21001



WHITE  
BL21011

*Large*



BLACK  
BL21002



WHITE  
BL21012

PRODUCT TYPE  
Inlay

COLLI  
1

ENVIRONMENT  
Indoor

DIMENSIONS

*Small*  
H: 6 cm / 2,36"  
W: 12 cm / 4,7"  
D: 12 cm / 4,7"

*Large*  
H: 12 cm / 4,7"  
W: 21 cm / 8,2"  
D: 21 cm / 8,2"

TECHNICAL SPECIFICATIONS

COLOURS  
Black (RAL 9005)  
White

MATERIALS  
Injection molded PE plastic

WEIGHT  
Small: 0,3 kg / 0,67 lb  
Large: 0,4 kg / 0,8 lb

PACKAGING TYPE  
Gift box

PACKAGING MEASUREMENTS  
(H × W × D)

*Small:*  
19 cm × 17 cm × 17 cm /  
7,5" × 6,7" × 6,7"

*Large:*  
22 cm × 33,5 cm × 19 cm /  
8,7" × 13,2" × 7,5"

MATERIALS & MAINTENANCE  
Please visit [audocph.com](http://audocph.com) for materials, care and maintenance instructions.

SMALL

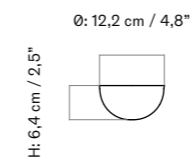

LARGE

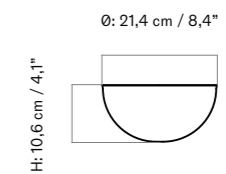



KUBUS FLOWERPOT  
Designed by *Søren Lassen*

Herb pot, vase or a simple container. The possibilities are endless. Another addition to the Kubus collection, Kubus Flowerpots come in three different sizes: Flowerpot 10, designed by Søren Lassen and Sarah Abbondio; Flowerpot 14; and Flowerpot 23, designed by Søren Lassen. The container is deeper than the classic Kubus Bowl, making this a highly versatile storage item. As the name indicates, it was originally intended as a home for plants and flowers, but with its elegant geometric shape it will sit happily in any space as a standalone piece. The Kubus Flowerpot comes in two distinctive monochrome powder-coated colors enabling it to fit into the interior aesthetic of any style-conscious home. Place it on the table, window sill, on the garden table, on the patio, or hang it on the wall with the Kubus Wall Bracket that give the Kubus Flowerpot a light, airy contemporary look. Like the other containers in the Kubus collection, this also comes with an insert that's recommended for planting.

*Flowerpot 10*



BLACK  
BL24001



WHITE  
BL24011

*Flowerpot 14*



BLACK  
BL24002



WHITE  
BL24012

*Flowerpot 23*



BLACK  
BL24003



WHITE  
BL24013

PRODUCT TYPE  
Bowl

COLLI  
Flowerpot 10: 4  
Flowerpot 14 and 23: 2

ENVIRONMENT  
Indoor

DIMENSIONS

*10*  
H: 10 cm / 3,9"  
W: 10 cm / 3,9"  
D: 10 cm / 3,9"

*14*  
H: 14 cm / 5,5"  
W: 14 cm / 5,5"  
D: 14 cm / 5,5"

*23*  
H: 23 cm / 9,1"  
W: 23 cm / 9,1"  
D: 23 cm / 9,1"

TECHNICAL SPECIFICATIONS

PRODUCTION PROCESS  
The frame is casted with zinc and afterwards shot blasted before it is powder coated. The bowl is casted with zinc and afterwards powder coated. The flower divider is laser cut and degreased before powder coated.

COLOURS  
Black (RAL 9005)  
White

MATERIALS  
Powder coated zinc

WEIGHT  
10: 0,655 kg / 1,44 lb  
14: 1,082 / 2,39 lb  
23: 2,679 / 5,91 lb

PACKAGING TYPE  
Gift box

PACKAGING MEASUREMENTS  
(H × W × D)

*10*  
11 cm × 11 cm × 10,8 cm / 4,33" × 4,33" × 4,25"

*14*  
21,2 cm × 16 cm × 16 cm / 8,35" × 6,3" × 6,3"

*23*  
24,5 cm × 28,5 cm × 28,5 cm / 9,65" × 11,22" × 11,22"

MATERIALS & MAINTENANCE  
Please visit [audocph.com](http://audocph.com) for materials, care and maintenance instructions.

10

14

23

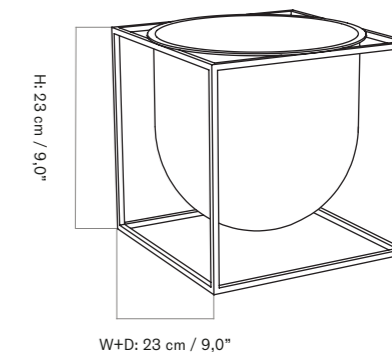
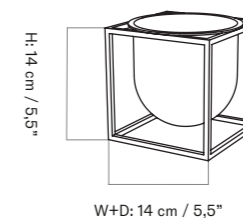
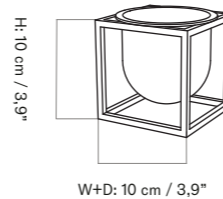



# KUBUS VASE LOLO

Designed by *Søren Lassen*

Kubus Vase Lolo was originally designed by Søren Lassen in 2014, but was launched in celebration of Audo's 10th anniversary 2018. The vase is a natural extension of the series, which has already seen the creation of the Kubus Line candlestick and Kubus Bowl to add to the original Kubus Candleholder. Whether it stands alone or as part of a collection of items, it looks crisp yet feminine when filled with light, colourful blooms. With its simplicity and precision, it also has a strong enough aesthetic to make a statement all on its own.



BLACK  
BL22001



WHITE  
BL22011

PRODUCT TYPE  
Vase

COLLI  
4

ENVIRONMENT  
Indoor

DIMENSIONS  
H: 24 cm / 9,4"  
W: 12 cm / 4,7"  
D: 12 cm / 4,7"

## TECHNICAL SPECIFICATIONS

PRODUCTION PROCESS  
The frame is casted with zinc and afterwards shot blasted before powder coated. The bowl is casted from aluminum and degreased before it is powder coated. The flower divider is laser cut and degreased before powder coated.

COLOURS  
Black  
White

MATERIALS  
Powder coated zinc

WEIGHT  
1,4 kg / 3,09 lb

PACKAGING TYPE  
Gift box

PACKAGING MEASUREMENTS  
(H x W x D)  
25,5 cm x 13 cm x 13 cm /  
10,04" x 5,12" x 5,12"

MATERIALS & MAINTENANCE  
Please visit [audocph.com](http://audocph.com) for materials, care and maintenance instructions.

